

23 March 2017

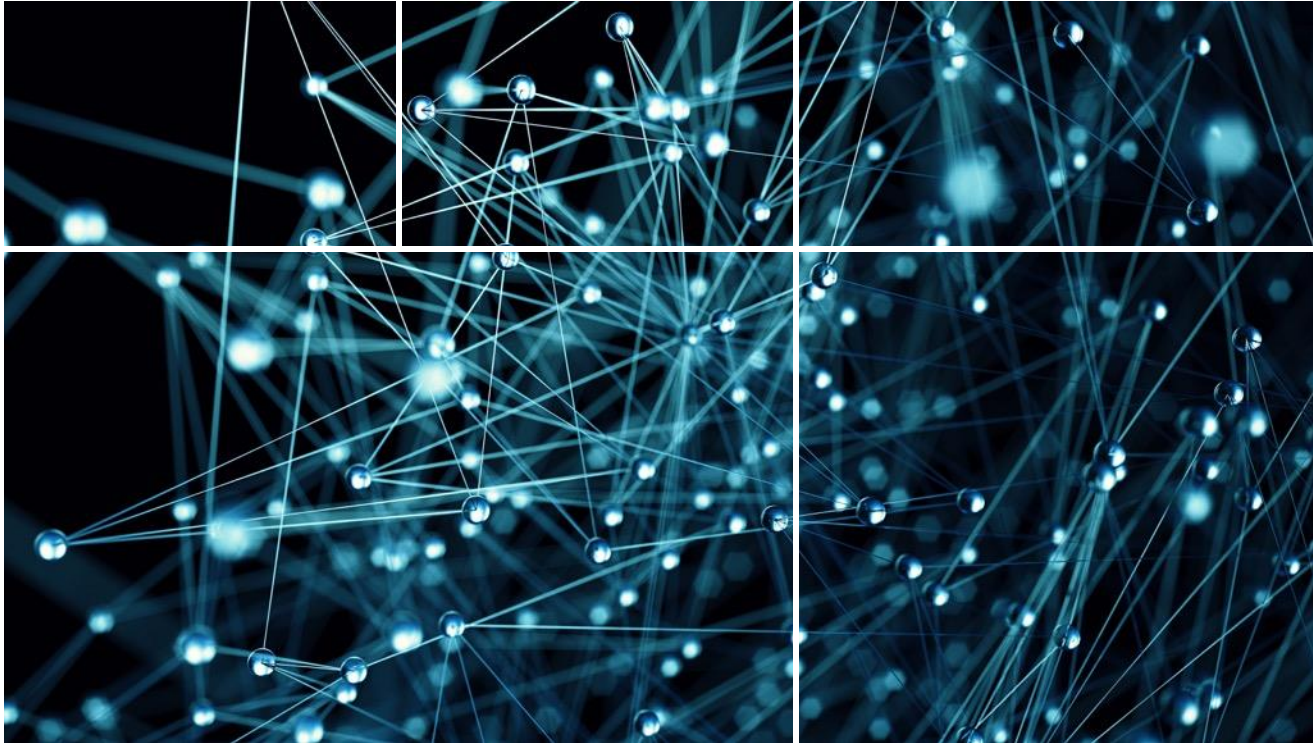

IPR and Patents

European Robotics
Forum 2017

Matthew Howell



Introduction to IPR and Patents

What is Intellectual Property?

Different types of IP

What is a patent?

How do we get patents?

Structure of a patent application

Patent claims

Patent infringement



What is Intellectual Property?

- The matrix of legal rights established to protect the fruits of intellectual effort
- Balance the interests of the state and those of the individual by providing limited exclusivity in exchange for wider dissemination of innovation
- Every organisation has IP!

IP Wheel





What is Intellectual Property?

Registered Rights

- Patents/Utility Models
- Registered Trade Marks
- Registered Designs

Unregistered Rights

- Know-How/Trade Secrets
- Common Law/Unregistered Trade Marks
- Unregistered Design Right
- Copyright/Database Rights

Patents

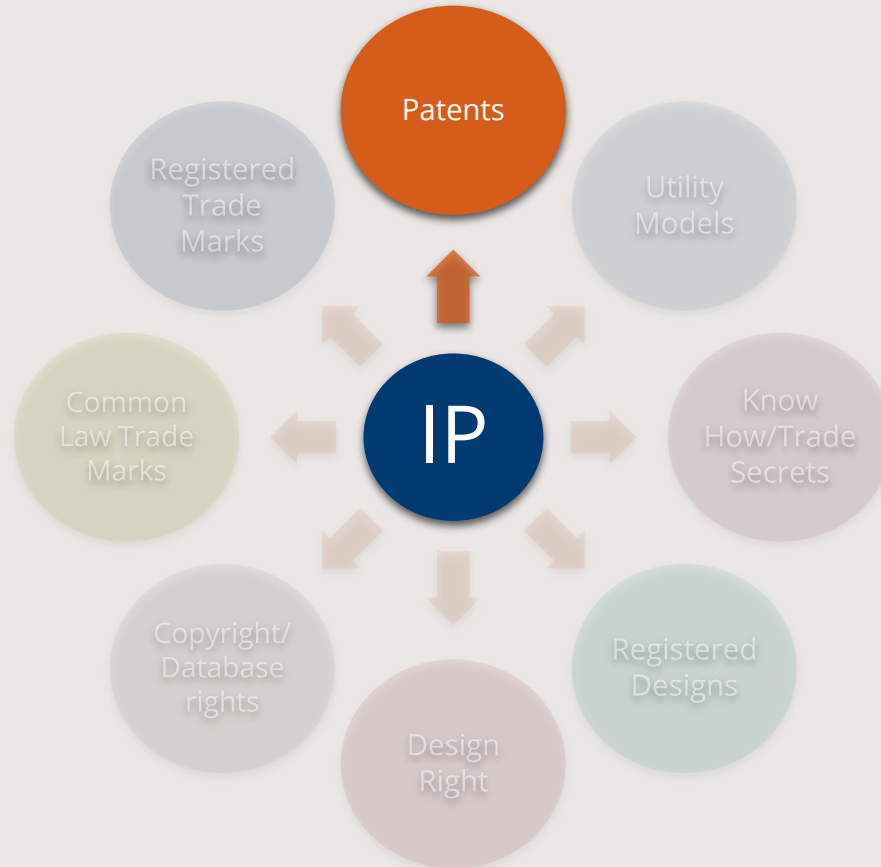



What is a patent?

- A state granted monopoly which allows owner to prevent commercial dealings in the patented invention
- Protects technical features of a product or process
- Up to 20 years duration
- Invention must be new and inventive
- No non-confidential disclosure prior to filing application
- Certain things are excluded by law from patent protection

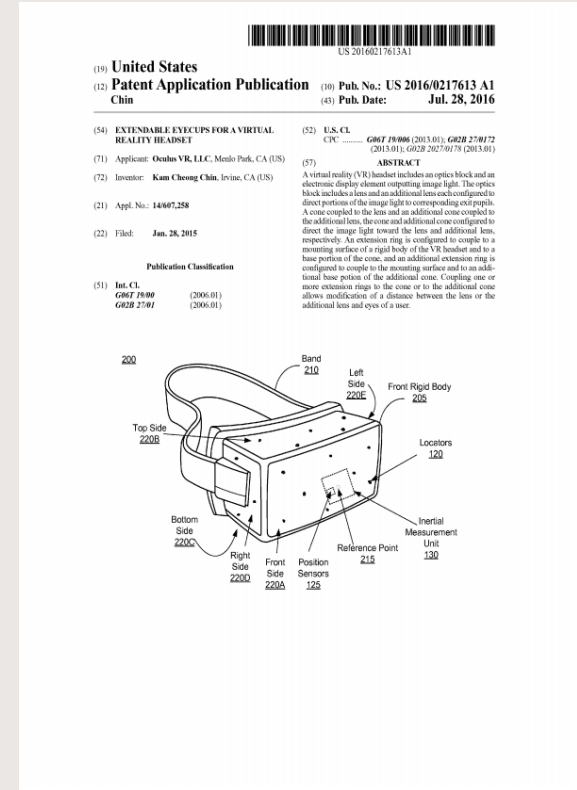

How do we get patents?

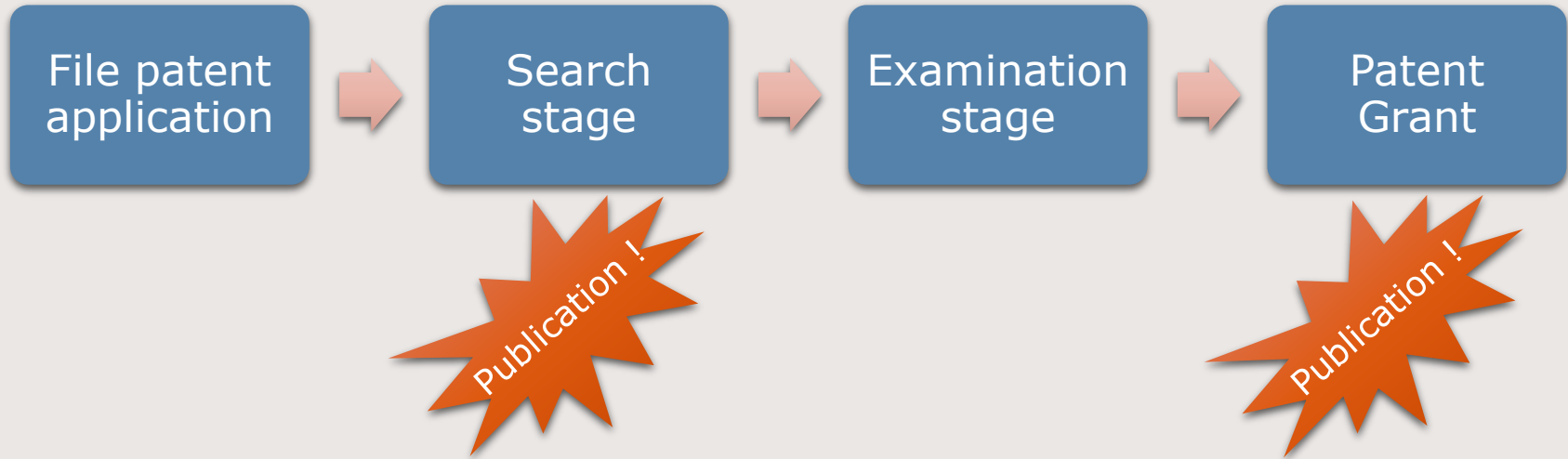

- Timescale to grant is usually 2 to 5 years in the UK, 4 to 8 years in Europe.
- Remember that renewal fees are payable after grant.



Structure of a patent application

- Background to the invention
 - sets out the technical background, identifying the technical problem solved by the invention
- Description
 - describes how the invention works, in enough detail that one skilled in the art can put the invention into practice
- Drawings
 - support the description
- Abstract
 - a formal requirement only to aid classification
- Claims
 - the most important part – define the scope of the monopoly sought



Patent claims

1. A device for holding together sheets of material comprising two interconnected arms arranged so that the sheets of material can be placed between them to be held frictionally together, the device comprising a single piece of material shaped to form the arms.
2. A device according to claim 1 in which the device is formed from a length of wire bent to form the arms.
3. A device according to claim 1 or 2 in which the arms lie substantially in a common plane.
4. A device according to claim 3 in which one arm has a portion bent out of the plane to form a lip.

Patent infringement

- Various acts can infringe a patent
 - making, importing, selling, offering to sell, using, storing a patented product
 - using or offering for use a process, selling, offering to sell, using, importing or storing a product obtained directly by a patented process
- How do you know if a product is an infringing product?
- Need to look at the claims of the granted patent
 - if the product has all of the features of an independent claim of the granted patent, the product is an infringing product



Patent infringement

1. A device for holding together sheets of material comprising two interconnected arms arranged so that the sheets of material can be placed between them to be held frictionally together, the device comprising a single piece of material shaped to form the arms.
2. A device according to claim 1 in which the device is formed from a length of wire bent to form the arms.
3. A device according to claim 1 or 2 in which the arms lie substantially in a common plane.
4. A device according to claim 3 in which one arm has a portion bent out of the plane to form a lip.

Infringement?

PLASTICLIPS

The revolutionary non-scratch paper clip. All plastic with no sharp ends to scratch your paper.

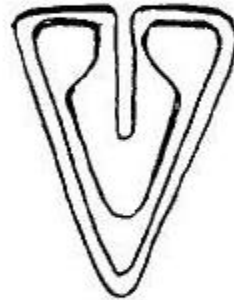

For samples and rates for bulk purchase contact
Plasticlips Company, PO Box 500 Derby.

Infringement?

Are you frustrated by small fiddly paper clips? Your troubles are over. Buy the new Jawclip manufactured exclusively by Dodgy Deal Limited.

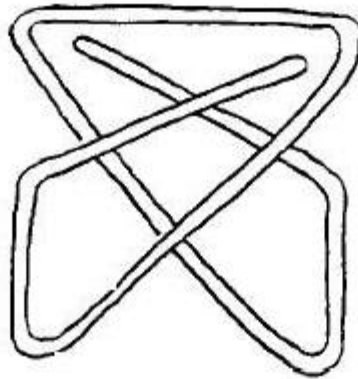

For a free sample and more information sent SAE to Dodgy Deal Limited, Unit 1, Newtown Industrial Estate. You know it makes sense.

Infringement?

The new **SNAP BACK** clip is now available to solve all your paper clipping problems: Just clip it on, snap back the arms and Hey Presto it's done. Send for your free sample now to **SNAP BACK CLIPS ENTERPRISES 1, Presto Way, Workhampton, Dorset.**

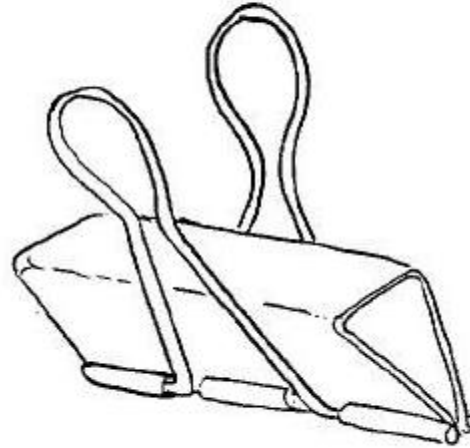

the **SNAP BACK** clip



Summary

- Patents protect inventions, i.e. technical solutions to technical problems
- Monopoly of up to 20 years, subject to payment of renewal fees
- Patents are territorial
- Application process
 - legal requirements of novelty, inventive step
 - formal requirements
- Only a granted patent can be infringed
- Claims define scope of protection
 - make sure you're looking at the claims as granted



Any questions?



Thank You!

Contact Details



Matthew Howell – mhowell@withersrogers.com



Stuart Latham – slatham@withersrogers.com



Anna Chatzimichali – achatzimichali@withersrogers.com



Patent and Trade Mark Attorneys



withersrogers.com

London • Bristol • Leamington Spa • Sheffield • Munich